

Residential Code Requirements:



This information applies to buildings covered under Part 9 of the OBC, including detached houses, semi detached, row houses. Not larger apartment buildings.



Housing has moved from the single family home to various methods with more density, including towers and mid rise buildings.





The Ontario Building Code:

- legal criteria which defines a set of **MINIMUM** standards for the construction of buildings
- standards which reflect on issues of life safety or fire safety do not permit variances

Residential Definitions:

- Part 9 of the Code has jurisdiction over residential construction (low density, detached, semi detached)
- medium density residential buildings are classed as Group C Occupancy: these include apartments, residential colleges, hotels, motels, dorms, residential schools... These are not addressed in this presentation - spaces can be smaller.

Minimum Room and Space Dimensions:

- the OBC sets out minimum room and space dimensions in an effort to set **MINIMUM** standards to ensure that spaces are (just) **ADEQUATE** for inhabitation
- calculated in terms of space per person, minimum dimensions for furniture, headroom clearance

a. Living Areas:

- shall have at least 13.5 m² of floor area and no dimension less than 3.0 m
- a minimum of 10% of the floor area must be provided in unobstructed glazing
- natural ventilation shall be provided

b. Dining Areas:

- shall have at least 3.25 m² of floor space when combined with other rooms, and at least 7.0 m² of area when not combined
- minimum dimension of 2.3 m
- minimum of 10% of the floor area must be provided as unobstructed glazing
- natural ventilation shall be provided



Dining rooms vary greatly in size. You need to be sure that furniture is accommodated. How big is the table? Can the chairs pull out fully? Are there sideboards/hutches?



c. Kitchen Areas:

- shall have at least 4.2 m² of floor area including the area occupied by base cabinets
- windows are not legally required
- if operable windows are not provided, mechanical ventilation must be provided (exhaust fan)

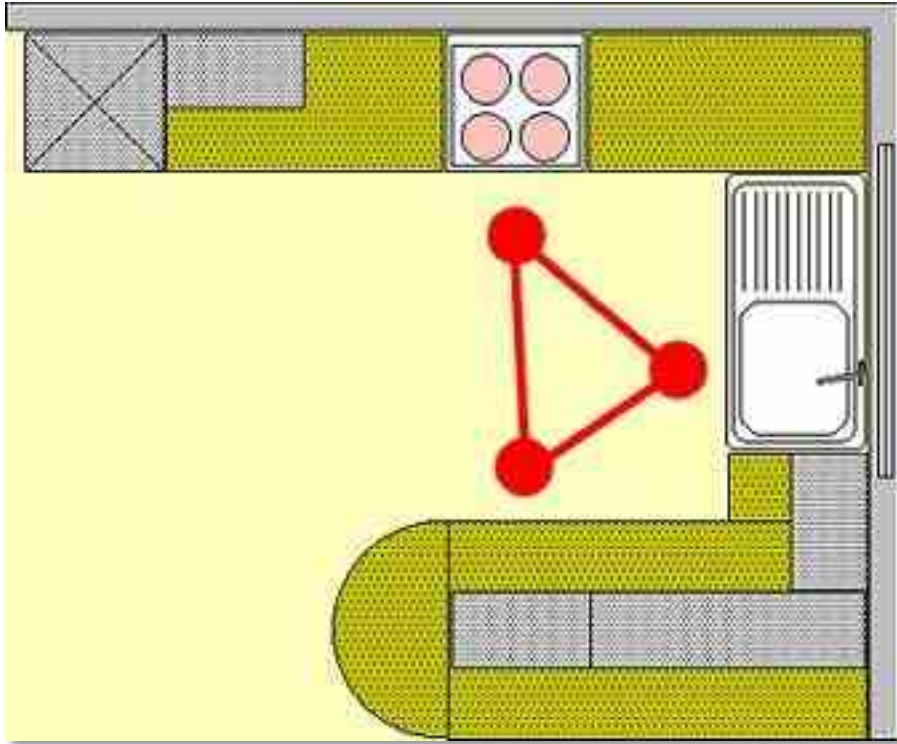

Ensure that appliances can all open without interfering with one another, and that standing space is provided.

Maintaining the “classic work triangle” is NOT a legal requirement. It just makes sense. The triangle should be no longer than 15’ in total.

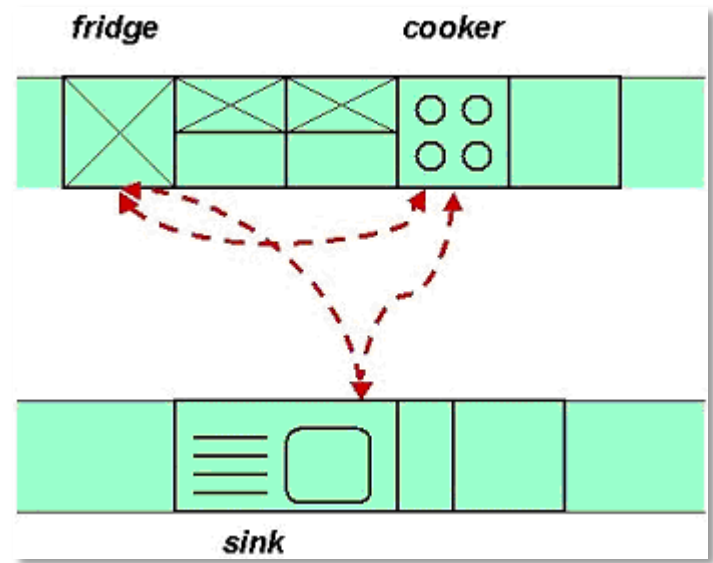



Required appliances will vary from jurisdiction to jurisdiction. Normal minimum: full fridge, 4 burner cooktop, oven, single sink. Dishwashers and microwaves are not required.

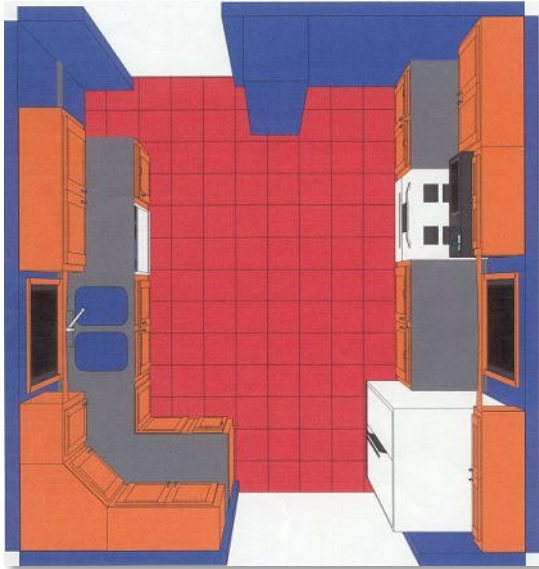

Either provide natural or mechanical ventilation.

Living, Dining and Kitchen Height Requirements:

- 2.3 m over at least 75% of the required floor area with a clear height of at least 2.1 m at any point over the required area

d. Primary Bedrooms:

- one bedroom shall have at least 9.8 m² of floor area where built in cabinets are not provided and 8.8 m² where built in closets are provided
- minimum dimension is 2.7 m
- at least 5% of the floor area shall be provided as unobstructed glazing
- natural ventilation must be provided



Bedrooms must have windows for natural light AND ventilation. Windows must also provide for safe FIRE egress. **WINDOWLESS BEDROOMS ARE ILLEGAL!**





“Legal” bedroom size varies as a function of included space for built-in closets. Not many people have stand-alone “wardrobes” to store their clothes. 1.5m of length per person is the minimum rule.



e. Secondary Bedrooms:

- other bedrooms shall have at least 7.0 m² of floor area where built in cabinets are not provided, and 6.0 m² where built in closets are provided
- minimum dimension is 2.0 m
- at least 5% of the floor area shall be provided as unobstructed glazing
- natural ventilation must be provided



How big is the bed?



With the exception of twin sized beds, access MUST be provided to 3 sides of the bed in order to make it.



Bedroom Height Restrictions:

- 2.3 m over at least 50% of the required floor area OR 2.1 m over 100% of the required floor area
- any part of the floor area having a height of less than 1.4 m shall not count when calculating required floor area



Not all of the floor area in these rooms "counts", nor can it all be "used".



Bedroom Fire Exits:

- bedroom windows in houses must be of an operable type such as a casement or slider that allows for egress in case of fire
- sills should be no more than 1.0m above the floor
- bedrooms must be not more than 1 storey above an adjacent grade
- Having a roof below the bedroom window to provide an escape path counts

f. Hallways:

- shall have a width of at least 860 mm except where the overall width of the building is less than 4.3 m, and this may be reduced to 710 mm
- minimum height 2.1 m

g. Bathrooms:

- every dwelling shall have a bathtub, a toilet and a sink (showers are extras)
- windows are not legally required, but if not provided, mechanical ventilation is required (exhaust fan)
- minimum height of 2.1 m in any area where a person would be in a standing position

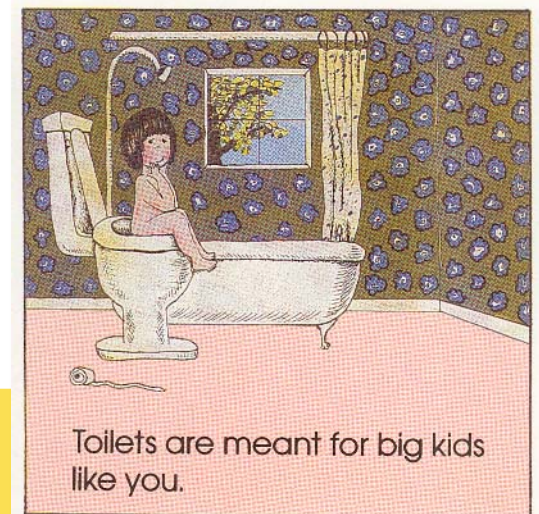

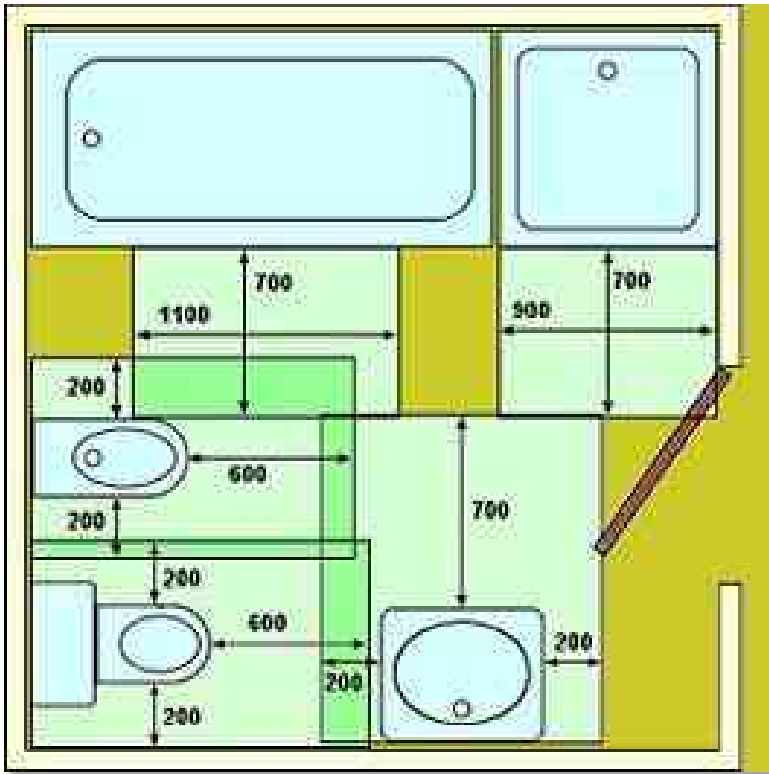

Various bathroom layouts are possible. Make sure that there is adequate room in front of the fixtures to use them.

Can you open and close the door easily?
 Airplane washrooms "work", but they are not very comfortable.

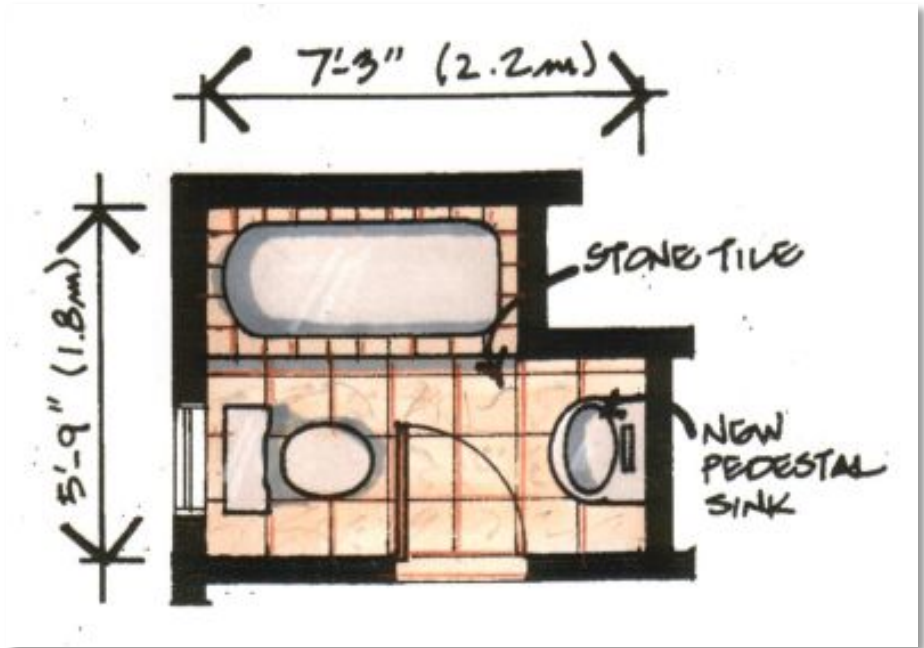



Egress and Access:

- every dwelling shall have a sufficient number of exits or egress doors so that it is not necessary to travel up or down more than one storey to reach a level served by an exit or egress door to a public corridor or exterior passageway
- where egress is onto a corridor, two exits shall be provided in opposite directions (like in an apartment type building)

Railings:

- Stair handrails 900mm (measure from the toe of the tread to the top of the handrail)
- Guard rails on landings 1.1m
- Platforms under 60cm above grade, no railings required
- Railings cannot be climbable (no horizontals)
- Can use a mesh as long as it is not climbable
- Space between pickets should not permit the passage of a 100mm diameter ball

Construction Type:

- up to 3 storeys, combustible construction is allowed (wood frame)
- 4 to 6 storeys, NON combustible construction, with fire separations of 1 or 2 hours (concrete block, light steel framing)
- over 6 storeys, NON combustible construction with a 2 hour fire separation on floor assemblies (reinforced concrete with concrete block)

**BARRIER
FREE DESIGN**
applies to all
public buildings

Figure 4.2.2.1
Accessible Toilet Stall

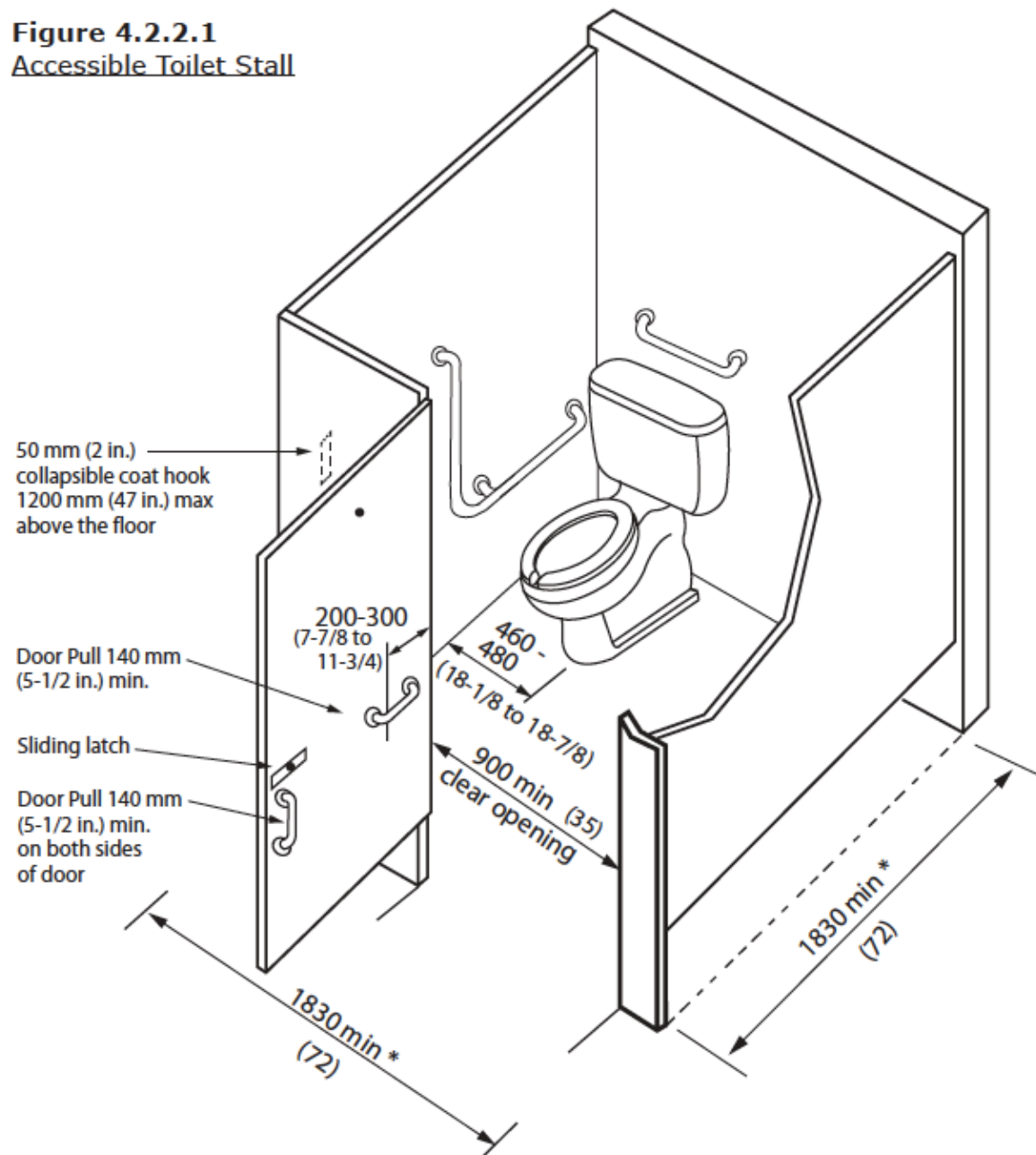

NOTE: In a retrofit situation where it is technically infeasible to provide the required clearances, the dimensions marked with an * may be reduced. Refer to 4.2.2 - Design Requirements.

Figure 4.2.2.2
Accessible Toilet Stall with
In-Swinging Door

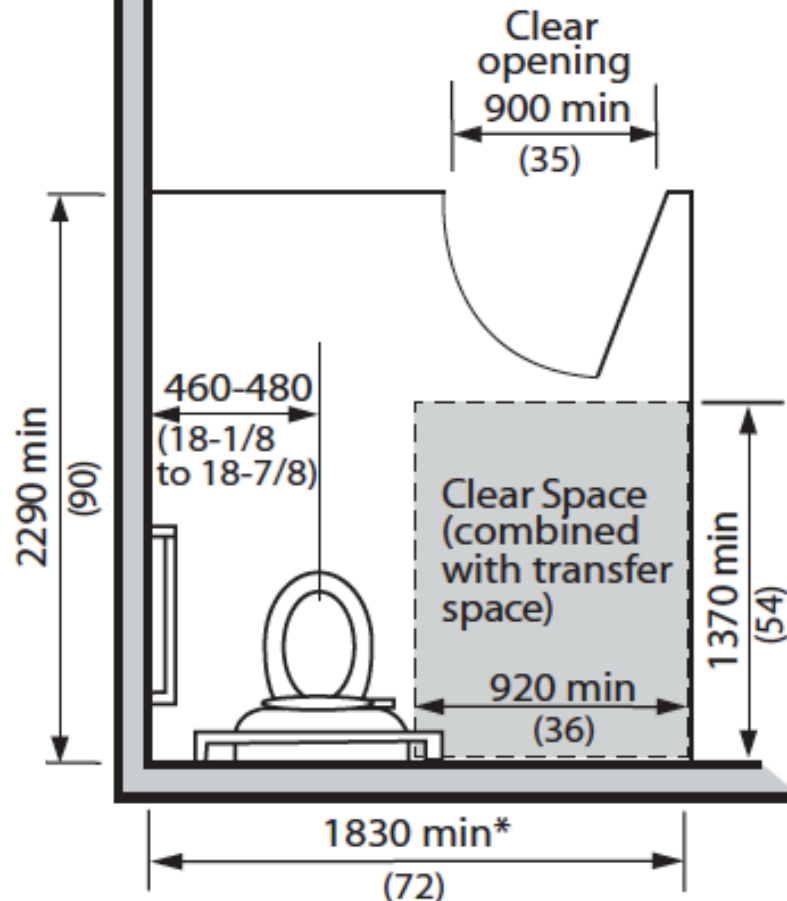

Note: In a retrofit situation where it is technically infeasible to provide the required clearances, the dimension marked with an * may be reduced to 1525 mm (60 in.) and the clear transfer space may be reduced to 760 mm (30 in.).

Figure 2

